



# BARCLAYS 2017 HIGH YIELD BOND AND SYNDICATED LOAN CONFERENCE

JUNE 8, 2017

# Forward Looking Statements



This report may contain forward-looking statements within the meaning of the Private Securities Litigation Reform Act of 1995, including, without limitation, statements with respect to the acquisition of MPG and the anticipated consequences and benefits of such acquisition and other information relating to matters that are not historical facts. These forward-looking statements involve certain risks and uncertainties that could cause actual results to differ materially from those expressed or implied by these statements. These risks and uncertainties include the ability to successfully operate and integrate MPG operations and realize estimated synergies, and the other factors detailed in the reports we file with the SEC, including those described under “Risk Factors” in our most recent Annual Report on Form 10-K and our Quarterly Reports on Form 10-Q. These forward-looking statements speak only as of the date of this communication. We expressly disclaim any obligation or undertaking to disseminate any updates or revisions to any forward-looking statement contained herein to reflect any change in our expectations with regard thereto or any change in events, conditions or circumstances on which any such statement is based.

It should also be noted that this presentation contains certain financial measures, including Adjusted EBITDA and Adjusted free cash flow, that are not required by, or presented in accordance with, accounting principles generally accepted in the United States, or GAAP. These measures are presented here to provide additional useful measurements to review our operations, provide transparency to investors and enable period-to-period comparability of financial performance. A description of non-GAAP financial measures that we use to evaluate our operations and financial performance, and reconciliation of these non-GAAP financial measures to the most directly comparable financial measures calculated and reported in accordance with GAAP, can be found starting on slide 28 under “Reconciliation of Non-GAAP Measures”.

# Agenda

- AAM's 1Q 2017 Highlights and 2017 Full Year Financial Outlook
- Industry Trends and Technology Leadership
- Diversification and Value Creation



**Delivering  
POWER.**

# AAM HIGHLIGHTS AND TARGETS

# 1Q 2017 AAM Highlights

## 1Q 2017 Financial Performance

**\$1.05B**

RECORD  
Quarterly  
Sales

**\$211M**

20.1% of Sales

RECORD  
Gross Profit  
RECORD  
Gross Margin

**\$184M**

17.5% of Sales

RECORD  
Adj. EBITDA\*  
RECORD  
Adj. EBITDA  
Margin



**New  
Global Business  
Awards**



**Recognized as a  
Supplier of the Year  
by General Motors**

# Completion of MPG Acquisition

Nearly

**\$7B**

Annual Revenues

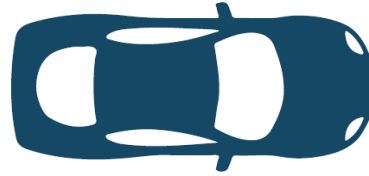

## Diversification

- Customer Base
- Product Portfolio
- Geographic Footprint
- Served Market
- Vehicle Segments



Presence in  
**17** Countries



**90** Facilities +



**25,000** Associates

**The acquisition of MPG was completed on April 6, 2017**

# AAM's Updated 2017 Financial Outlook

As disclosed on May 5, 2017



|                               | 2017 Full Year Targets             |
|-------------------------------|------------------------------------|
| US SAAR*                      | ≈ 17.5 million light vehicle units |
| AAM's Consolidated Sales      | ≈ \$6.1 Billion                    |
| Adj. EBITDA* Margin           | In the range of 17% to 18%         |
| Adj. Free Cash Flow*          | ≈ 5% of AAM's consolidated sales   |
| Capital Expenditures (Cap Ex) | ≈ 8% of AAM's consolidated sales   |

- These targets reflect the expected impact of the MPG acquisition beginning on April 6, 2017. MPG's pre-acquisition financial results from January 1, 2017 to April 5, 2017 will be excluded from AAM's 2017 financial results and are excluded from our 2017 full year outlook.
- We expect to incur significant costs and payments related to restructuring and acquisition-related activities as well as significant purchase price adjustments and related effects on the income statement during 2017. The impact of these has been excluded from our Adjusted EBITDA margin and Adjusted free cash flow targets.

**We expect 2017 to exhibit continued strong margin performance and cash flow generation**

\* For definitions of terms, please see the attached appendix

# 2017 Sales Walkdown

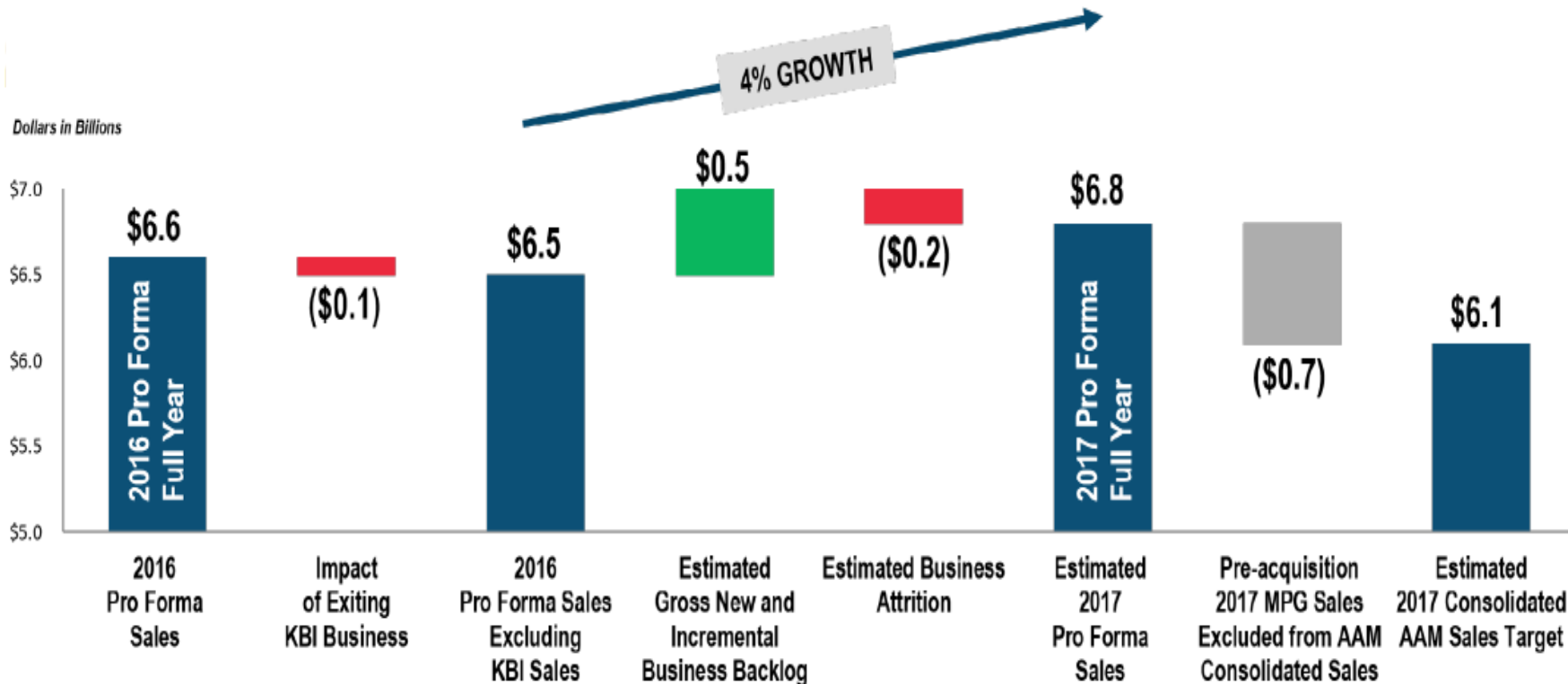

**Excluding the KBI impact, AAM expects ≈4% sales growth on a pro forma basis**





**Delivering  
POWER.**

# INDUSTRY TRENDS AND TECHNOLOGY LEADERSHIP

# Powertrain Projections

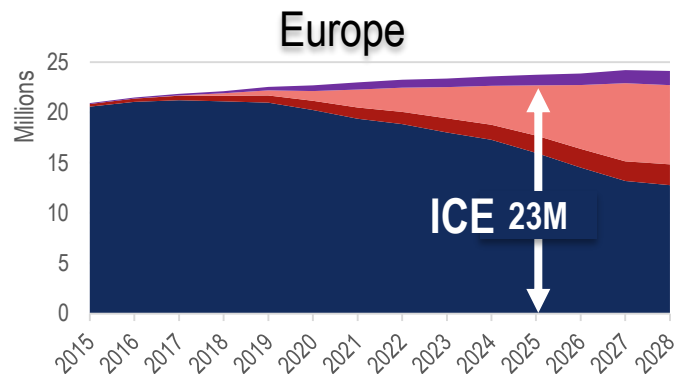
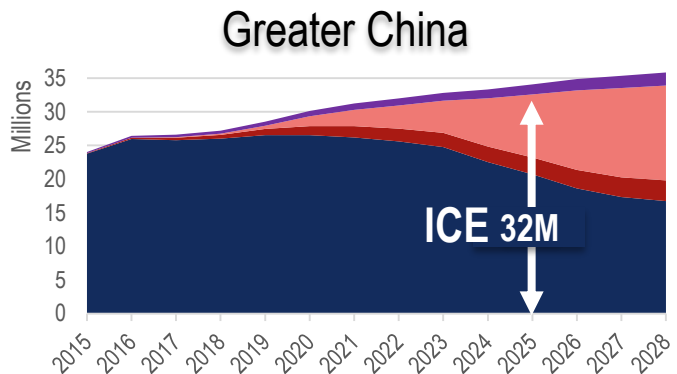
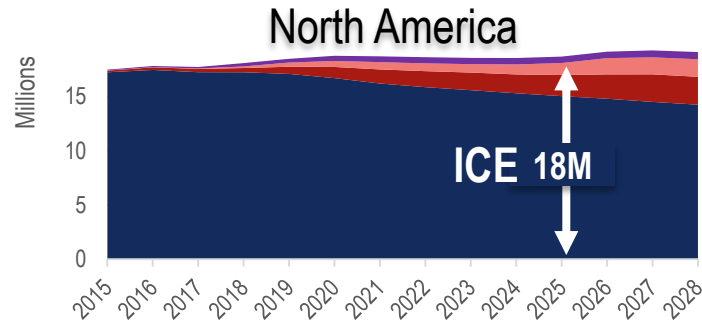
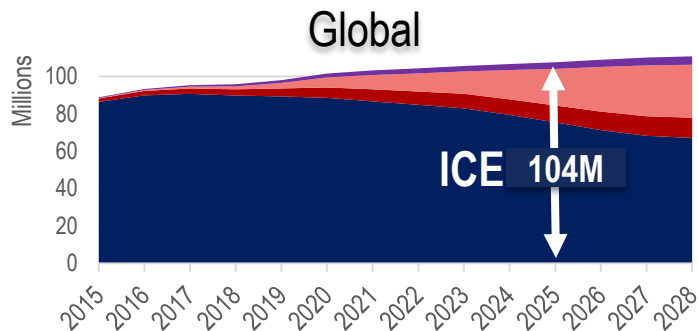

- Electric
- Hybrid-Mild
- Hybrid-Full
- ICE

**For at least the next decade, the internal combustion engine (ICE) is expected to be the main source of power for vehicles**

# North America Light Vehicle Production Mix

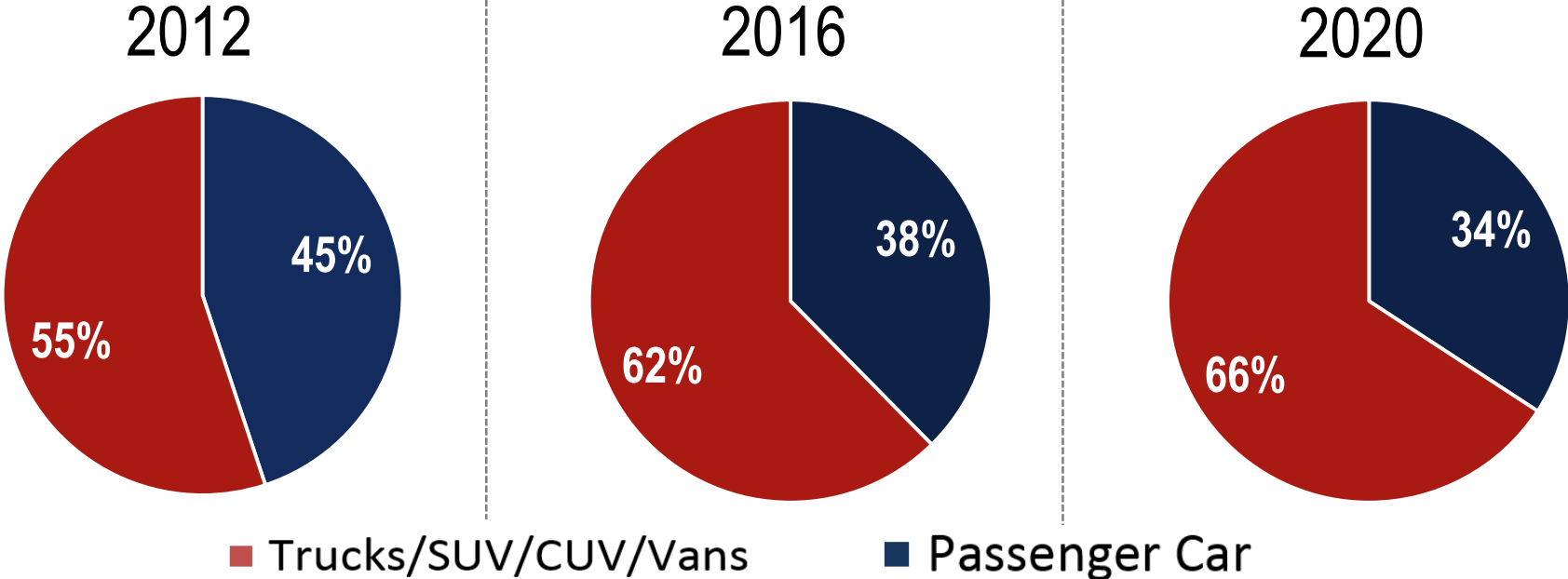

**Continued strength in pickup trucks/SUVs and increasing demand for crossover vehicles is favorable for AAM**

# Technology Leadership: The Power of Innovation

## GREEN and EFFICIENT

- High efficiency axle portfolio and all-new QUANTUM™ lightweight axles and drive units
- New product designs and manufacturing processes leading to light-weighting and cost savings
- Power dense technology allows forged products to maintain strength and quality within a smaller design
- Use of advanced materials



## SAFETY and PERFORMANCE

- EcoTrac® disconnecting AWD system
- Driveshaft technologies incorporate noise, vibration, and harshness (NVH) system integration and tunable crash features
- Precision-ground gears with dampening capability improve NVH
- Vibration control systems provide solutions to offset vibration inherent in downsized engines



## CONNECTIVITY and ELECTRIFICATION

- e-AAM™ hybrid & electric driveline systems
- Actuators and sensors
- Electronic LSD front-drive axles
- Integrated wheel torque distribution controls
- Fully integrated vehicle controls



**Aligned with global automotive trends**

# EcoTrac<sup>®</sup> Disconnecting AWD Systems



**EcoTrac<sup>®</sup>** - utilizes electronics and connectivity to improve Fuel Economy, Safety, and Performance

## KEY ATTRIBUTES

- Advanced mechatronics (motors, actuators and sensors) integrated within mechanical technology
- Disconnects at the power transfer unit (PTU), causing the driveshaft to stop spinning
- Can automatically engage when it senses AWD traction requirement
- Benefits:
  - Improved vehicle fuel economy without sacrifice in AWD functionality
  - Improved vehicle handling and safety
  - Our Gen II design, which begins production in 2018, will reduce the parasitic loss associated with traditional AWD system by 90%

**ECO TRAC**  
DISCONNECTING AWD SYSTEM BY 



EcoTrac<sup>®</sup> Disconnecting PTU

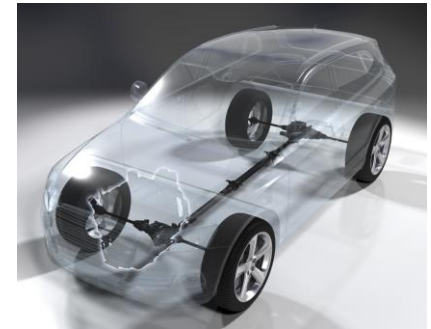

# EcoTrac<sup>®</sup> Sales Growth

**54% CAGR  
from 2013  
to 2019!**

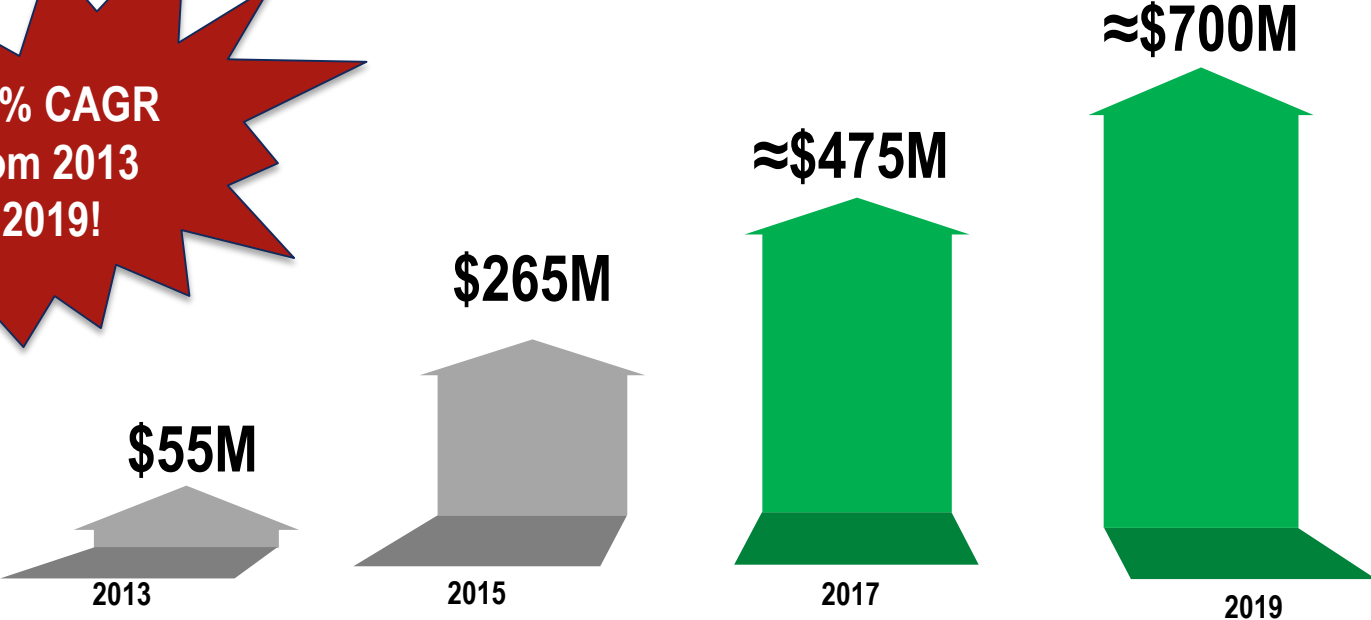

**Featured on three global programs by 2018**

# e-AAM™ Hybrid & Electric Drivelines



**e-AAM™** - AAM is well positioned to benefit from the global trend of electrification

## KEY ATTRIBUTES

- Power dense design allows for easy integration for multiple vehicle platforms
- Modular solutions for passenger cars / CUVs
- Torque vectoring options provides maximum traction and ride control
- Benefits:
  - Improves fuel efficiency up to 30% and reduces CO<sub>2</sub> emissions
  - Improved vehicle performance and drive quality
  - Improved handling and stability

**e**  
**AAM**

HYBRID AND ELECTRIC  
DRIVELINE SYSTEMS BY 



Electric Rear Drive Unit



**An e-AAM program included in our new business backlog will launch in 2018**

**QUANTUM™** - All-new, completely redesigned family of lightweight axles and drive units

## KEY ATTRIBUTES

- Industry first technology along with a revolutionary design
- Significant mass reduction (up to 35%)
- In combination, additional efficiency and weight reduction can deliver 1% to 1.5% improved vehicle fuel economy
- Scalable across multiple applications— without loss of performance or power
- Streamlined manufacturing process for key driveline components.

**QUANTUM™**  
LIGHTWEIGHT AXLE TECHNOLOGY BY 



QUANTUM™ Rear Axle

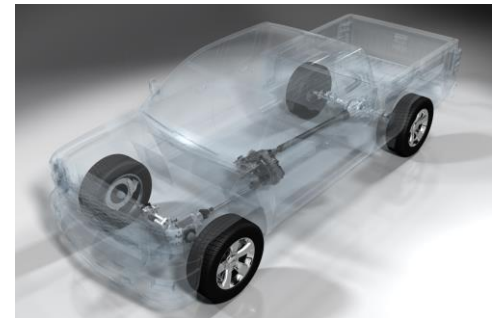



# High Performance Powertrain Components



## Light Weighting

Old Design



New Design



Savings:

- 40% weight savings
- 25% anticipated cost savings

## Strength

Old Design



New Design



Gear technology maintains strength in a smaller gear design

## Noise Reduction



Precision-ground gears with dampening capability improve NVH

## Vibration Control



Solutions to offset vibration inherent in downsized engines



**Delivering  
POWER.**

**DIVERSIFICATION AND VALUE CREATION**

# Comprehensive Solutions from Engine to Driveline



Our diverse product portfolio and technologies provide continued growth and exciting cross-selling opportunities

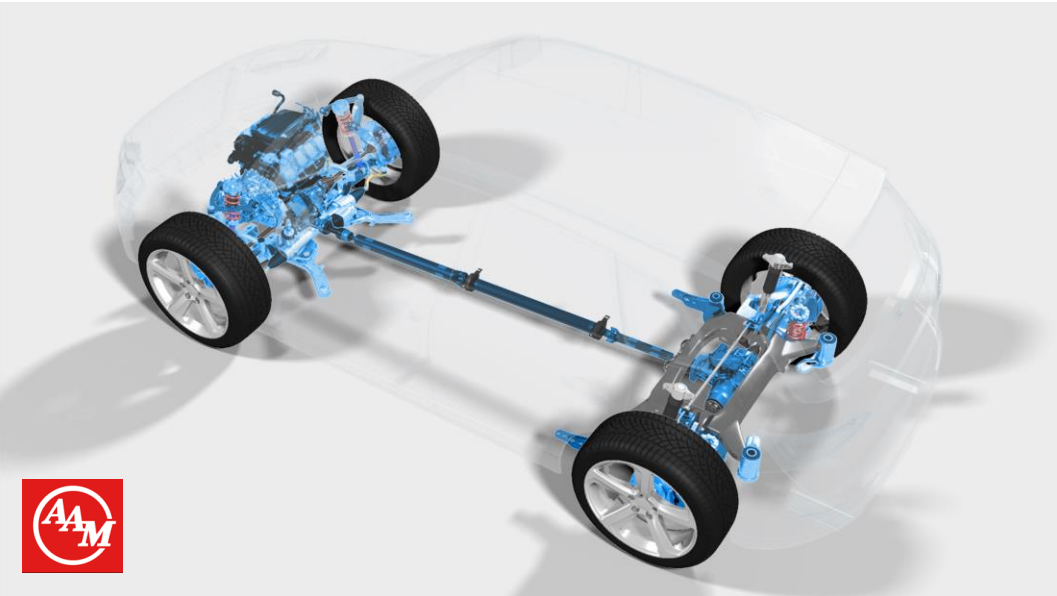

## DRIVELINE

- Rear and front axles
- Rear drive modules
- Power transfer units
- Driveshafts
- Transfer cases
- Electric drive units

≈ \$3.7 billion

## METAL FORMING

- Ring / pinion gears
- Axle / transmission shafts
- Differential gears
- Transmission gears
- Suspension components

≈ \$1.5 billion

## CASTINGS

- Axle carriers
- Differential cases
- Steering knuckles
- Control arms
- Turbo charger housings
- Brackets

≈ \$800 million

## POWERTRAIN

- Transmission module and differential assemblies
- Aluminum valve bodies
- Vibration control systems
- Connecting rods
- VVT products

≈ \$1.1 billion

\*Based on 2016 actual amounts before eliminations of intercompany sales of approximately \$0.5 billion

# Expanded Product Portfolio

- Diverse product offerings across engine, transmission, driveline, and safety-critical applications
- Expanded reach into commercial vehicle and industrial equipment markets
- Reduced reliance on GM's full-size truck and SUV products

AAM 2016 External Sales by Product

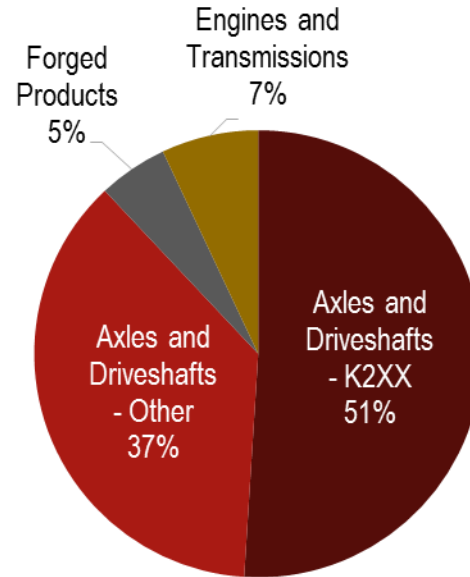

Pro forma 2016 External Sales by Product  
(including impact of MPG acquisition)

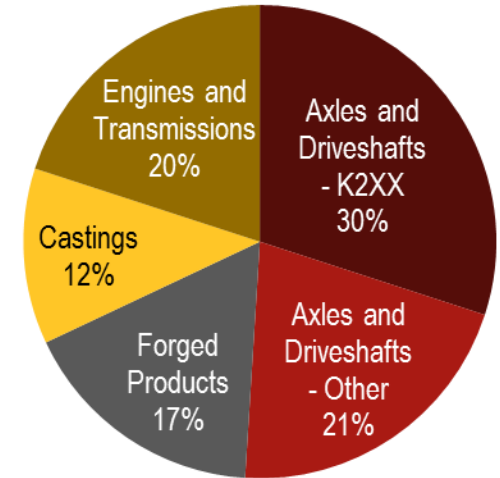

# Accelerated Customer Diversification

**AAM 2016 Sales by Customer**

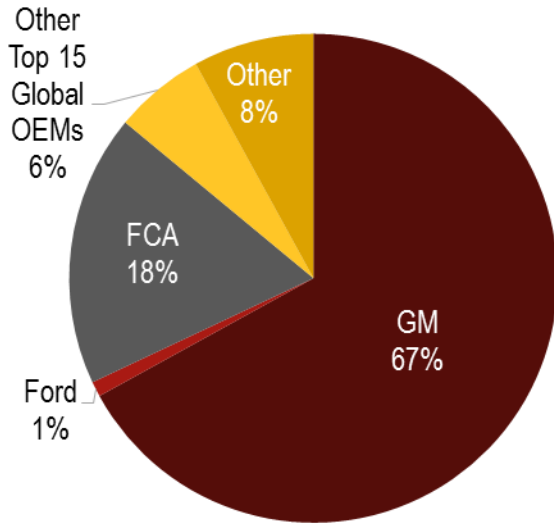

**Pro forma 2016 Sales by Customer**  
(including impact of MPG acquisition)

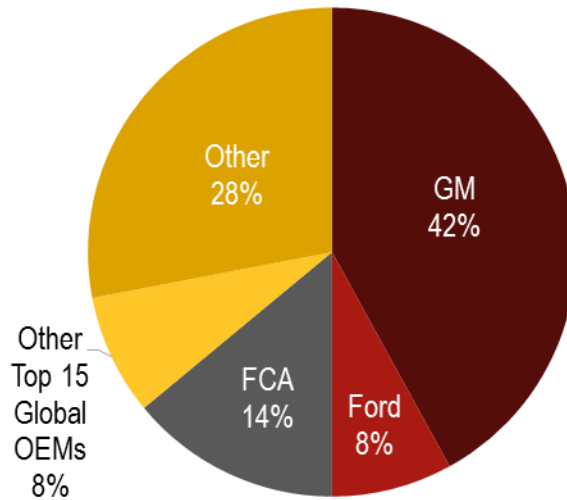

**AAM 2020E Sales by Customer**

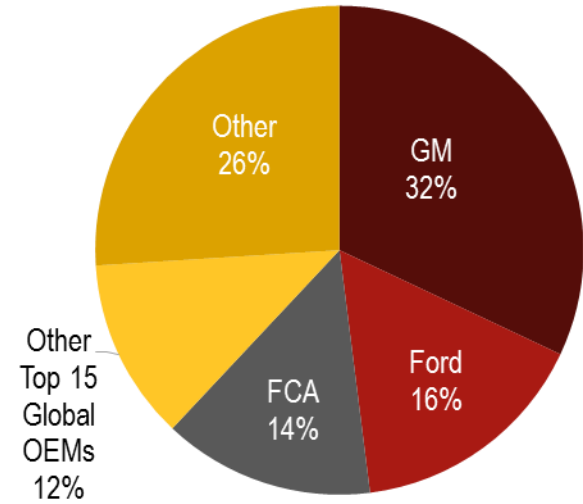

\* Top 15 Global OEMs determined based on total 2015 sales

# AAM's Gross New and Incremental Business Backlog



As disclosed on May 5, 2017

## \$1.5 BILLION: 2017-2019

### Backlog by Vehicle Segment

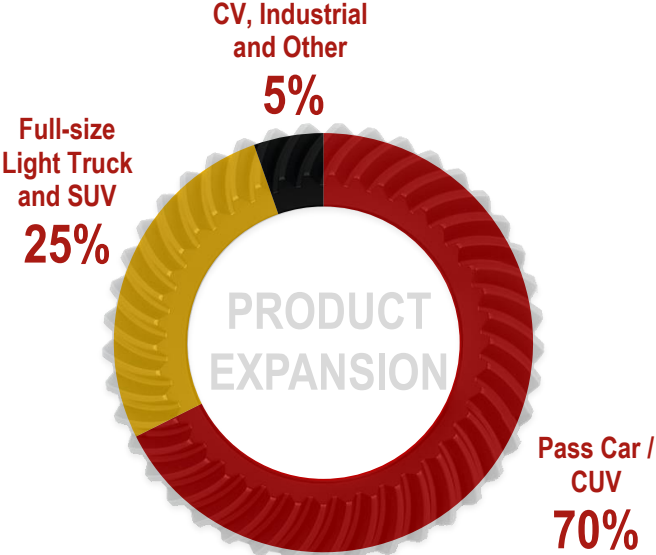

### Backlog by Global Market

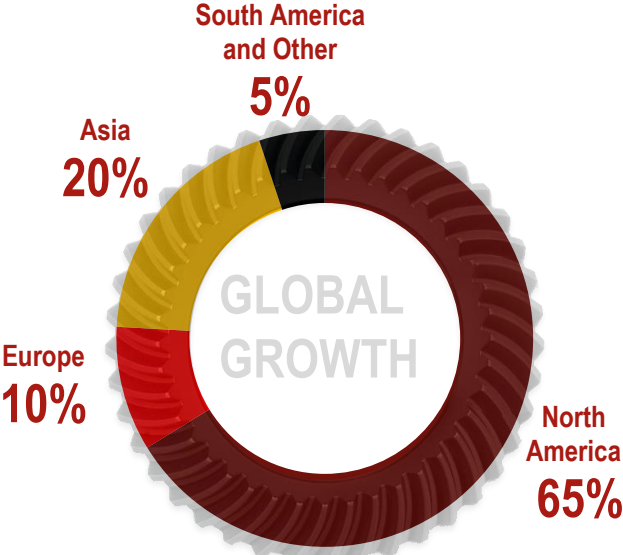

Over 70% relates to Non-GM business

# Anticipated Synergies from MPG Acquisition



| Sources of Cost Savings  | Targeted Annual Profit Impact |
|--|-------------------------------|
| <b>Overhead</b> <ul style="list-style-type: none"><li>Optimize operating structure</li><li>Elimination of redundant public company costs</li></ul>   | ≈ \$45 - \$50 million         |
| <b>Purchasing</b> <ul style="list-style-type: none"><li>Combine global purchasing to leverage larger scale</li><li>Direct and indirect material opportunities</li><li>Insourcing initiatives</li></ul> | ≈ \$45 - \$50 million         |
| <b>Other Cost Savings</b> <ul style="list-style-type: none"><li>Manufacturing initiatives</li><li>Plant loading optimization / facility rationalization</li></ul>                                      | ≈ \$10 - \$20 million         |
| <b>Total Targeted Annual Improvement</b>   | ≈ \$100 - \$120 million       |

## Timing and Cost to Achieve

Targeting 70% of expected annual run rate savings by the end of the first full year and 100% in the second full year

We estimate the costs required to achieve our synergy plan are approximately equal to one year of savings

# Pro Forma Debt Reduction Target

As presented on November 17, 2016

Pro Forma Net Debt\* and Net Leverage Ratio\*

Liquidity<sup>(1)</sup>

Debt Maturities<sup>(2)</sup>

## Net Debt and Net Leverage Ratio

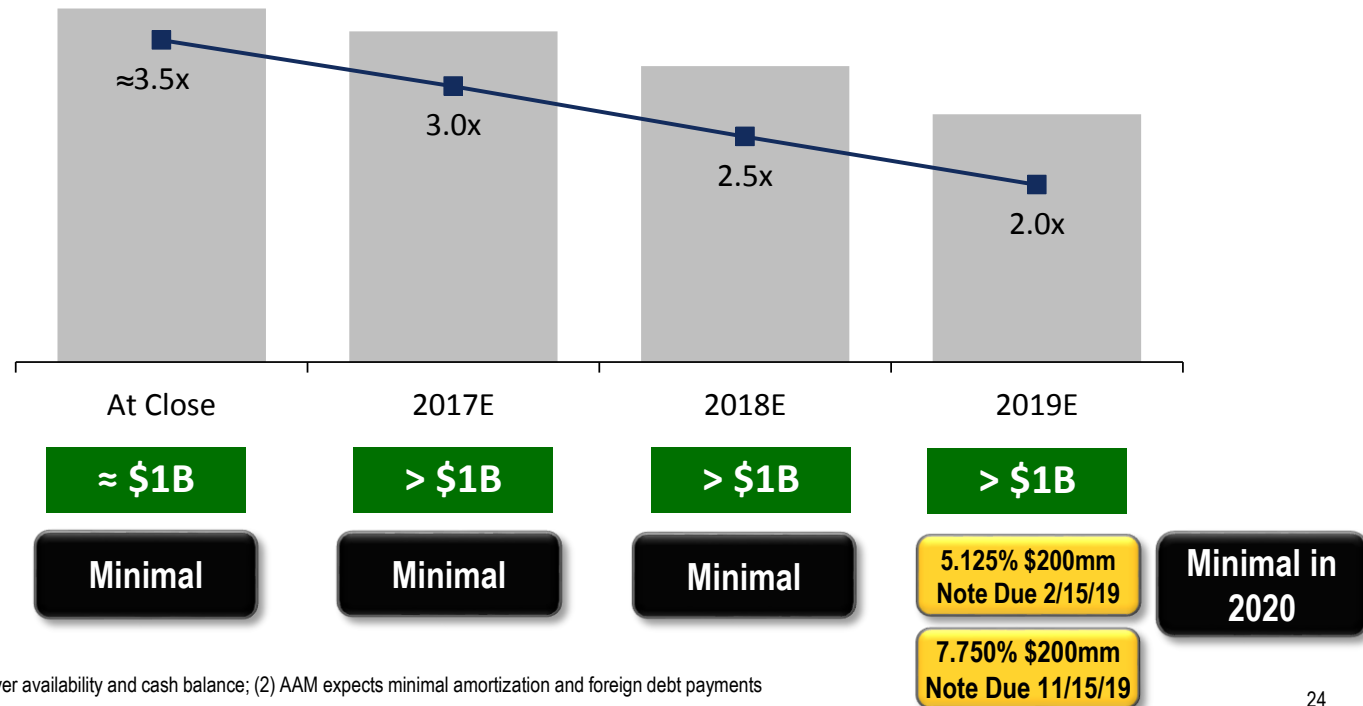

Note: Reflects company targets; (1) Reflects combined revolver availability and cash balance; (2) AAM expects minimal amortization and foreign debt payments

\*For definitions of terms, please see the attached appendix≈



# Expected Pro Forma EBITDA vs. Cash Payments



- Targeting Adjusted EBITDA well above projected cash requirements
- Variable cost structure allows for flexibility during periods of lower volumes
- Positioned to be cash breakeven in a 25% - 30% downturn scenario

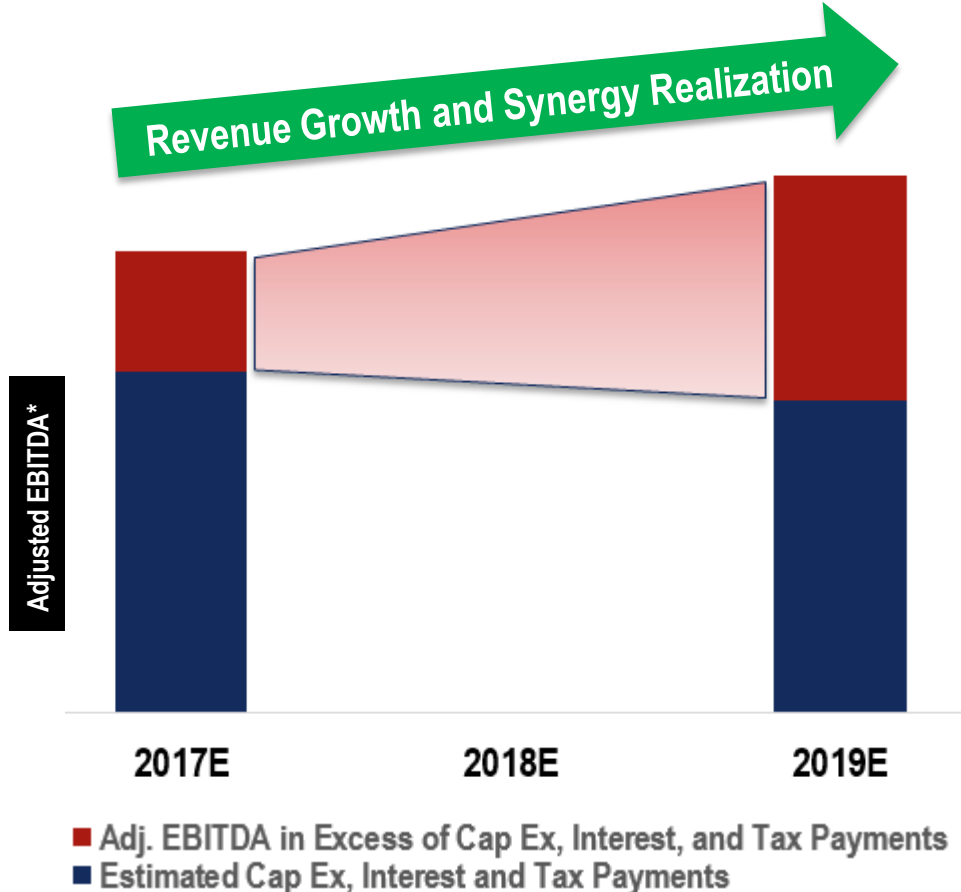

\*For definitions of terms, please see the attached appendix



- Increased size and scale
- Customer and product diversification
- Enhanced geographic footprint
- Served market and content per vehicle expansion
- Strong profit and free cash flow margins
- Identifiable cost synergies of ≈\$100 – 120 million
- Extended debt maturity profile
- Strong liquidity position

**Stronger Financial Profile and Enhanced Cash Flow Generation**



**Delivering  
POWER.**

# APPENDIX

# Reconciliation of Non-GAAP Measures



In addition to the results reported in accordance with accounting principles generally accepted in the United States of America (GAAP) included within this presentation, we have provided certain information, which includes non-GAAP financial measures. Such information is reconciled to its closest GAAP measure in accordance with Securities and Exchange Commission rules and is included in the following slides.

Certain of the forward-looking financial measures included in this presentation are provided on a non-GAAP basis. A reconciliation of non-GAAP forward-looking financial measures to the most directly comparable financial measures calculated and presented in accordance with GAAP is not practical given the difficulty of projecting event driven transactional and other non-core operating items, as well as purchase price adjustments and their related effects in any future period. The magnitude of these items, however, may be significant.

**Earnings before Interest Expense, Income Taxes, Depreciation and Amortization (EBITDA) and Adjusted EBITDA Reconciliation**  
 (\$ in millions)

|   | <b>Three Months Ended</b> |                 |
|---|---------------------------|-----------------|
|   | <b>March 31,</b>          |                 |
|   | <b>2017</b>               | <b>2016</b>     |
| Net income                                  | \$ 78.4                   | \$ 61.1         |
| Interest expense                            | 25.5                      | 23.6            |
| Income tax expense                          | 7.5                       | 15.3            |
| Depreciation and amortization               | 56.2                      | 49.8            |
| EBITDA                                      | 167.6                     | 149.8           |
| Restructuring and acquisition-related costs | 16.0                      | —               |
| Adjusted EBITDA                             | <u>\$ 183.6</u>           | <u>\$ 149.8</u> |
| As % of net sales                           | <u>17.5 %</u>             | <u>15.5 %</u>   |

# Notes to Supplemental Data



We define EBITDA to be earnings before interest expense, income taxes, depreciation and amortization. Adjusted EBITDA is defined as EBITDA excluding the impact of restructuring and acquisition-related costs. We believe that EBITDA and Adjusted EBITDA are meaningful measures of performance as they are commonly utilized by management and investors to analyze operating performance and entity valuation. Our management, the investment community and the banking institutions routinely use EBITDA, together with other measures, to measure our operating performance relative to other Tier 1 automotive suppliers. EBITDA and Adjusted EBITDA should not be construed as income from operations, net income or cash flow from operating activities as determined under GAAP. Other companies may calculate EBITDA and Adjusted EBITDA differently.

We define free cash flow to be net cash provided by operating activities less capital expenditures net of proceeds from the sale of property, plant and equipment. Adjusted free cash flow excludes the impact of cash payments for restructuring and acquisition-related costs and settlements of pre-existing accounts payable balances with acquired entities. We believe free cash flow and Adjusted free cash flow are meaningful measures as they are commonly utilized by management and investors to assess our ability to generate cash flow from business operations to repay debt and return capital to our stockholders. Free cash flow and Adjusted free cash flow are also key metrics used in our calculation of incentive compensation. Other companies may calculate free cash flow and Adjusted free cash flow differently.

We define net debt to be total debt, net less cash and cash equivalents. We define net leverage ratio to be net debt divided by Adjusted EBITDA. We believe that net leverage ratio is a meaningful measure of financial condition as it is commonly used by management, investors and creditors to assess capital structure risk. Other companies may calculate net leverage ratio differently.

We define US SAAR as the seasonally adjusted annual rate of light vehicle sales in the United States

We define CAGR to be the compound annual growth rate of sales.